

	High Voltage component		High Voltage Battery		Emergency cable cut
	Fuel Cell		High Voltage power cable		electronic key distance
	Hydrogen tank		Service-Disconnect		Steering wheel adjustment
	Direction of overpressure valve		Battery 12 V		Height control truck, by air system
	Manual gas shut-off valve		Emergency door opener		Seat height adjustment
	Autom. overpressure safety valve		Air-conditioning component		Unlocking front flap
	Vehicle on Hydrogen Fuel Cell Electric Vehicle				Compressed air tank

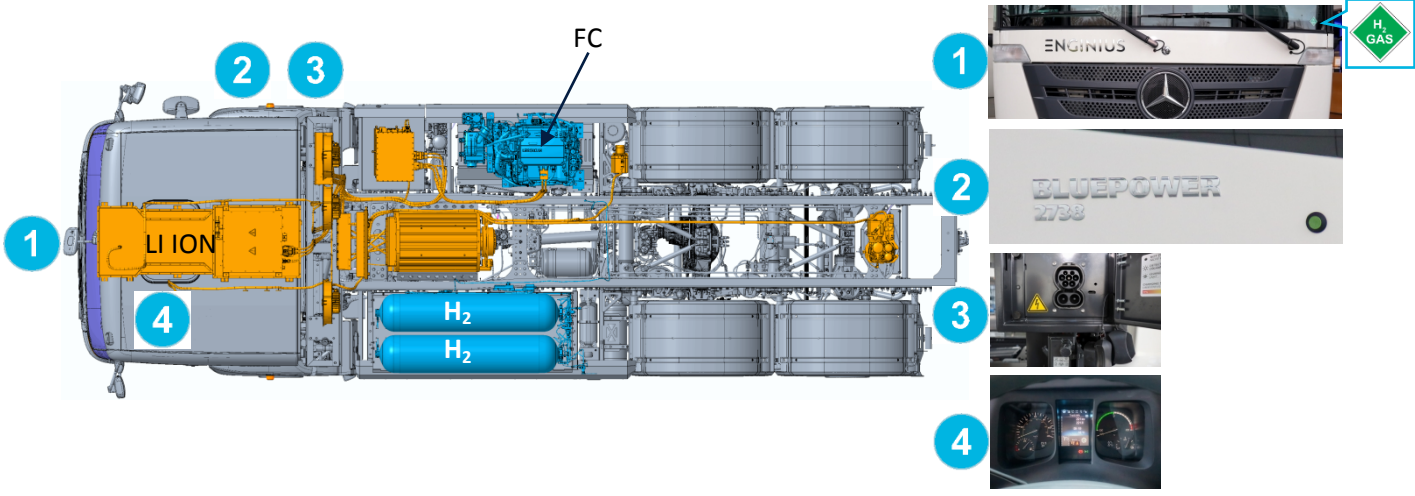

1. Identification / recognition



2. Immobilisation / stabilisation / lifting



Gearbox in neutral position:

Turn the direction of travel preselection on the multifunction lever to position N.



Electronic parking brake:

Press the button or pull the lever over the pressure point. The electric parking brake is activated when the LED is illuminated.

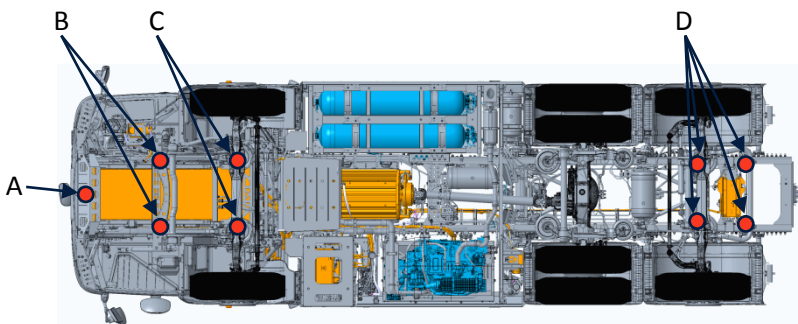

Lifting points (Bottom view)

- A Coupling jaw
 - B At the front end of the vehicle frame
 - C On the front axle
 - D In the trailing axle area (with plate only)
- High Voltage components
 Hydrogen components



3. Disable direct hazards / safety regulations

Ignition Off: RC-Key



Press the START-STOP button without applying the service brake.

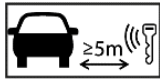

Keep the electronic vehicle key at a distance of 5 metres.



The absence of engine noise does not mean that the vehicle is switched off.
Use of personal protective equipment.



Emergency High Voltage Disconnect:

The high-voltage disconnection devices are located on both sides behind the mainframe on the fender, on the driver's and passenger's side and are labelled.



To ensure that there is no residual voltage in the high-voltage system, wait approx. 10 minutes after switching off.

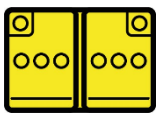

Disconnect Low Voltage batteries

Remove the cover of the on-board power supply batteries on the right-hand side behind the cab. Mechanically loosen the negative cable of the on-board power supply batteries at the screw connection and secure against unintentional contact.

4. Access to the occupants



Opening the folding door in an emergency.

Vehicles with locking cylinders:

- 🔵 Unlock the folding door.
- 🔵 Turn control knob to emergency position.
- 🔵 Open the folding door manually



Steering wheel adjustment

- ⦿ Press the lower section of the button. The steering column is unlocked.
- ⦿ Adjust the multifunction steering wheel height and angle
- ⦿ Press the upper section of the button. The steering column is locked.



Seat height adjustment

- (1) Length adjustment
- (2) Height adjustment
- (3) Fast lowering

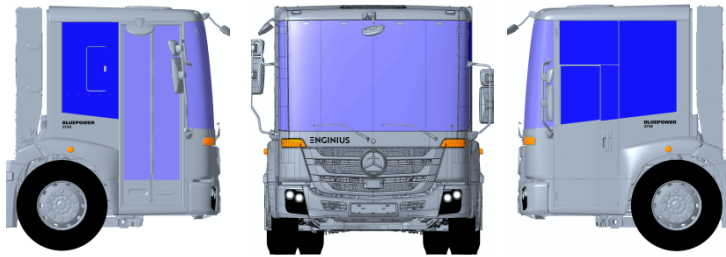

- VSG Laminated safety glass**
- ESG Toughened safety glass**

5. Stored energy / liquids / gases / solids

Li-ION



All high-voltage cables are provided with orange-coloured insulation.

H₂



Class 2: Flammable gasses

H ₂	kg	
4*	16	412 L
2	8	206 L

*Option



Main cooling circuit (A)

60 L

+

BZ (B)

55 L

(A) 50% Ethylene Glycol (red)
50% Water

(B) 54% Ethylene Glycol (green)
46% Deionised Water



6. In case of fire

Use water (H₂O) in high volumes to extinguish a vehicle fire.
Use water (H₂O) in high volumes to cool down the Li-ion battery.



Warning: Re-ignition of the battery



Check the battery temperature with an IR thermal imaging camera or a thermometer.



Attention: hydrogen burns with an almost invisible flame.



7. In case of submersion

There is no risk of voltage being applied to the bodywork.

After recovering the vehicle:

1. Drain the water from the interior.
2. initiate deactivation of the high-voltage system (see chapter 3)

8. Towing / transportation / storage

When recovering a vehicle from the danger zone, the vehicle with electric drive may only be moved at walking speed.

Park a badly damaged vehicle in a safe place and at a safe distance from other vehicles.



Warning: Re-ignition of the battery

















9. Important additional information

More information you will find in the *ENGINIUS BLUEPOWER® - Rescue Guide*.

10. Explanation of pictograms used

	General warning sign		Attention
	Warning, Electricity		Gasses under pressure
	Attention: hydrogen burns with almost invisible flame		Flammable
	Capacity		Hazard to the human health
	IR-infrared camera		Corrosives
	Use water to extinguish the fire		Acute toxicity